

KLAPPSCHLOSS CODE/RFID
SERRURE À VOLET CODE/RFID
SERRATURA INCASSATA CODE/RFID
CERRADURA ABATIBLE CODE/RFID
CLASP LOCK CODE/RFID



CODE Lock



RFID Lock

Benutzerhandbuch
Manuel de l'utilisateur
Manuale per l'utente
Manual de uso
User handbook

INHALTSVERZEICHNIS
SOMMAIRE
SOMMARIO
ÍNDICE
TABLE OF CONTENTS

Informationen Informations Informazioni Información Information	3	Programmierung RFID Lock Programmation RFID Lock Programmazione RFID Lock Programación RFID Lock Programming RFID Lock	14
Produktübersicht CODE Lock, RFID Lock Aperçu du produit CODE Lock, RFID Lock Panoramica del prodotto CODE Lock, RFID Lock Vista general del producto CODE Lock, RFID Lock Product overview CODE Lock, RFID Lock	4	Programmierung Funktionen Programmation fonctions Programmazione funzioni Programación funciones Programming functions	18
Initialisierung CODE Lock Initialisation CODE Lock Inizializzazione CODE Lock Inicialización CODE Lock Initialization CODE Lock	6	Modulaustausch Remplacement des modules Sostituzione moduli Sustitución módulo Module replacement	22
Programmierung CODE Lock Programmation CODE Lock Programmazione CODE Lock Programación CODE Lock Programming CODE Lock	9	Batteriewechsel Remplacement de batterie Sostituzione della batteria Cambio de batería Changing battery	26
Initialisierung RFID Lock Initialisation RFID Lock Inizializzazione RFID Lock Inicialización RFID Lock Initialization RFID Lock	12	Fehlersuche Détection d'erreurs Ricerca guasti Búsqueda de errores Troubleshooting	27

Die nachfolgende Montage- und Bedienungsanleitung ist als Sicherheitsmassnahme zwingend zu befolgen. Sie ist sämtlichen Beschäftigten zur Kenntnis zu bringen und von diesen zu beachten!
Benutzerhandbuch bitte nicht im Schrank aufbewahren!

Les instructions suivantes de montage et d'utilisation doivent impérativement être appliquées comme mesures de sécurité. Elles doivent être portées à la connaissance de tous les collaborateurs et respectées de ceux-ci! **Ne pas conserver le manuel d'utilisation dans l'armoire!**

Le seguenti istruzioni per il montaggio e l'utilizzazione devono imperativamente essere rispettate per poter garantire le misure di sicurezza. L'intero personale ne deve essere a conoscenza e le deve rispettare! **Non conservare le istruzioni per l'uso nell'armadio!**

Como medida de seguridad, es imprescindible seguir las instrucciones del presente manual de instalación y uso. ¡Todos los operarios deberán conocerlas y respetarlas! **No conservar el Manual de Instrucciones dentro del armario.**

The following mounting and operating instructions must be observed for safety. All employees should be informed about them and observe them! **Please do not place the user manual in the cabinet!**



Warnhinweise
 Attention
 Attenzione
 Precaución
 Warning notices



+10 bis +40 °C
 +10 à +40 °C
 +10 a +40 °C
 +10 a +40 °C
 +10 to +40 °C



Beachten / Befolgen
 Respecter / Suivre
 Considerare / Seguire
 Observar / Para seguir
 To observe / To follow



Entsorgung
 Elimination
 Smaltimento
 Eliminación
 Disposal



Informationen
 Informations
 Informazioni
 Información
 Information



Vorsicht, ESD-Schutzmassnahmen einhalten!
 Attention, nous vous prions de respecter les mesures de sécurité ESD!
 Attenzione, vi preghiamo di rispettare le misure di sicurezza ESD!
 Atención, mantenga las medidas de protección ESD.
 Caution, please observe ESD protective measures!



Montageanleitung
 Instruction de montage
 Istruzioni per il montaggio
 Instrucción de montaje
 Assembly instructions

PRODUKTÜBERSICHT CODE LOCK, RFID LOCK
APERÇU DU PRODUIT CODE LOCK, RFID LOCK
PANORAMICA DEL PRODOTTO CODE LOCK, RFID LOCK
VISTA GENERAL DEL PRODUCTO CODE LOCK, RFID LOCK
PRODUCT OVERVIEW CODE LOCK, RFID LOCK



CODE Lock

siehe S. 6
 voir p. 6
 vedi p. 6
 véase p. 6
 see p. 6



LED

Zahlentasten 0–9
 Touches numériques 0–9
 Tasti numerici 0–9
 Teclas numéricas 0–9
 Numeric keys 0–9

ENTER-Taste
 Touche ENTER
 Tasto ENTER
 Botón INTRO
 ENTER button

USB-Anschluss
 Raccordement USB
 Connettore USB
 Conexión USB
 USB-port

Batteriefach
 Compartiment pour batterie
 Compartimento per batteria
 Compartimento pilas
 Battery compartment

Batterien 1,5 V, Typ AA (FR6)
 Batteries 1,5 V, type AA (FR6)
 Batterie 1,5 V, tipo AA (FR6)
 Pilas 1,5 V, tipo AA (FR6)
 Batteries 1,5 V, type AA (FR6)





RFID Lock

siehe S. 12
voir p. 12
vedi p. 12
véase p. 12
see p. 12



NFC Antenne
NFC antenne
NFC antenna
NFC antena
NFC antenna



Programmier-Badge:

Benutzer anlernen/löschen

Badge programmable:

Créer et supprimer un utilisateur

Badge programmable:

Imparare/cancellare l'utente

Badge programmable:

Crear y eliminar un usuario

Programmable badge:

Create/delete a user



Benutzer-Badge

Schrank öffnen

Badge de l'utilisateur

Ouvrez l'armoire

Badge utente

Aprire l'armadio

Badge utente

Aprire el armario

User badge

Open the cabinet

LED:



Freigabe Entriegelung
Validation déblocage
Conferma sblocco
Confirmación desbloqueo
Unlocking enabled



Abbruch/Fehler
Interruption/erreurs
Interruzione/errore
Cancelar/error
Cancel/error

INITIALISIERUNG CODE LOCK
INITIALISATION CODE LOCK
INIZIALIZAZIONE CODE LOCK
INICIALIZACIÓN CODE LOCK
INITIALIZATION CODE LOCK



Auslieferungszustand: LISTA Werkscode 1 2 3 4 5 ist werkseitig vorinstalliert.
Etat de livraison, code LISTA 1 2 3 4 5 est préinstallé en usine.
Stato alla fornitura, codice di fabbrica LISTA 1 2 3 4 5 è preinstallato.
Código de apertura preinstalado de fábrica 1 2 3 4 5 está preinstalada de fábrica.
LISTA factory code 1 2 3 4 5 and was preset at the factory.

Zum ersten Mal öffnen
 Premier déverrouillage
 Aperto per la prima volta
 Abrir por primera vez
 Unlocking for the first time

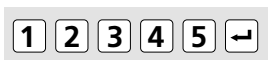

1 x Beep

1

8-stellige Lock-ID eingeben
Introduire 8 caractères de Lock-ID
Inserire 8 cifre Lock-ID
Introducir 8 dígitos Lock-ID
Enter 8 digits of Lock-ID

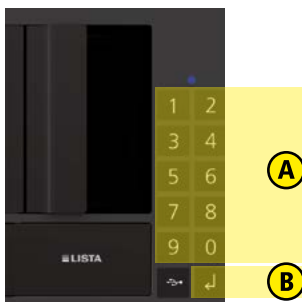

zum Beispiel / par exemple / per esempio /
 por ejemplo / for example:
 1 2 3 4 5 6 7 8 (8 digits)



(8 digits)

1 x Beep

Lock-ID wiederholen
 Répéter Lock-ID
 Ripetere Lock-ID
 Repetir Lock-ID
 Repeat Lock-ID

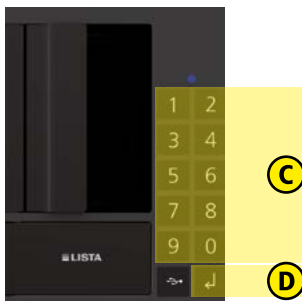

(8 digits)

3 x Beep

Ihre Lock-ID notieren:
Noter votre Lock-ID:
Nota il tuo Lock-ID:
Tomar nota del Lock-ID:
Note your Lock-ID:

Lock-ID



Lock-ID unbedingt in die freien Felder eintragen. Lock-ID kann nur mit LISTA Access Software geändert werden.
Entrez Lock-ID absolument dans les champs libres. Le Lock-ID ne peut être modifiée avec le LISTA Access Software.
Introducir Lock-ID a los campos libres. Il codice maestro può essere modificato solo con il LISTA Access Software.
Inserisci Lock-ID assolutamente nei campi liberi. El código maestro sólo puede cambiarse con el LISTA Access Software.
Insert Lock-ID necessarily into the free fields. The Lock-ID can only be changed with LISTA Access Software.

Mit der Lock-ID kann der Schrank nicht geöffnet werden. Diese dient lediglich der Programmierung.
L'armoire ne peut pas être ouverte au moyen du Lock-ID. Celui-ci sert uniquement à la programmation.
Il Lock-ID non permette di aprire l'armadio. Serve soltanto alla programmazione.
Con el ID de Lock no puede abrirse el armario, solo sirve para la programación.
The cabinet cannot be opened using the Lock-ID. It is intended for programming purposes only.

**BENUTZERCODES
CODES UTILISATEURS
CODICI UTENTE
CÓDIGO USUARIOS
USER CODES**



**Benutzercodes in Tabelle eintragen
Entrez le code d'utilisateur dans le tableau
Introducir código de usuario en el cuadro
Inserisci il codice utente nella tabella
Insert user code in table**

LISTA	
.....	<input type="text"/> <input type="text"/> <input type="text"/> <input type="text"/> <input type="text"/> <input type="text"/>
.....	<input type="text"/> <input type="text"/> <input type="text"/> <input type="text"/> <input type="text"/> <input type="text"/>
.....	<input type="text"/> <input type="text"/> <input type="text"/> <input type="text"/> <input type="text"/> <input type="text"/>
.....	<input type="text"/> <input type="text"/> <input type="text"/> <input type="text"/> <input type="text"/> <input type="text"/>
.....	<input type="text"/> <input type="text"/> <input type="text"/> <input type="text"/> <input type="text"/> <input type="text"/>
.....	<input type="text"/> <input type="text"/> <input type="text"/> <input type="text"/> <input type="text"/> <input type="text"/>
.....	<input type="text"/> <input type="text"/> <input type="text"/> <input type="text"/> <input type="text"/> <input type="text"/>
.....	<input type="text"/> <input type="text"/> <input type="text"/> <input type="text"/> <input type="text"/> <input type="text"/>
.....	<input type="text"/> <input type="text"/> <input type="text"/> <input type="text"/> <input type="text"/> <input type="text"/>
.....	<input type="text"/> <input type="text"/> <input type="text"/> <input type="text"/> <input type="text"/> <input type="text"/>
.....	<input type="text"/> <input type="text"/> <input type="text"/> <input type="text"/> <input type="text"/> <input type="text"/>
.....	<input type="text"/> <input type="text"/> <input type="text"/> <input type="text"/> <input type="text"/> <input type="text"/>
.....	<input type="text"/> <input type="text"/> <input type="text"/> <input type="text"/> <input type="text"/> <input type="text"/>
.....	<input type="text"/> <input type="text"/> <input type="text"/> <input type="text"/> <input type="text"/> <input type="text"/>
.....	<input type="text"/> <input type="text"/> <input type="text"/> <input type="text"/> <input type="text"/> <input type="text"/>
.....	<input type="text"/> <input type="text"/> <input type="text"/> <input type="text"/> <input type="text"/> <input type="text"/>
.....	<input type="text"/> <input type="text"/> <input type="text"/> <input type="text"/> <input type="text"/> <input type="text"/>
.....	<input type="text"/> <input type="text"/> <input type="text"/> <input type="text"/> <input type="text"/> <input type="text"/>
.....	<input type="text"/> <input type="text"/> <input type="text"/> <input type="text"/> <input type="text"/> <input type="text"/>
.....	<input type="text"/> <input type="text"/> <input type="text"/> <input type="text"/> <input type="text"/> <input type="text"/>
.....	<input type="text"/> <input type="text"/> <input type="text"/> <input type="text"/> <input type="text"/> <input type="text"/>
.....	<input type="text"/> <input type="text"/> <input type="text"/> <input type="text"/> <input type="text"/> <input type="text"/>

**PROGRAMMIERUNG CODE LOCK
PROGRAMMATION CODE LOCK
PROGRAMMAZIONE CODE LOCK
PROGRAMACIÓN CODE LOCK
PROGRAMMING CODE LOCK**

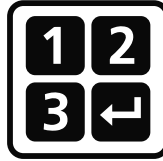

2A

**Benutzer anlernen
Enseigner aux utilisateurs
Enseñar a los usuarios
Insegnare usuario
Teach users**

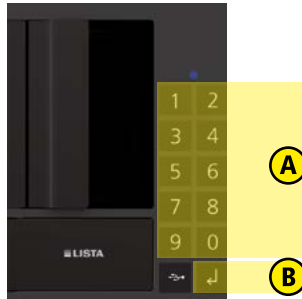

Lock-ID eingeben, (S. 7)
Introduire le Lock-ID, (S. 7)
Inserire il Lock-ID, (S. 7)
Introducir Lock-ID, (S. 7)
Enter Lock-ID, (S. 7)

Lock-ID



(8 digits)

1 x Beep

Taste 1 drücken
Appuyer sur la touche 1
Premere il tasto 1
Pulse el botón 1
Press the button 1



1 x Beep

Benutzercode eingeben
Introduire code utilisateur
Inserire codice utente
Introducir código usuario
Enter user code

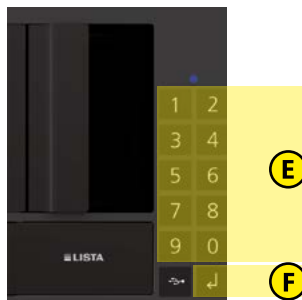

4–6 stellig
4–6 caractères
4–6 caratteri
4–6 dígitos
4–6 digits

zum Beispiel / par exemple / per esempio /
por ejemplo / for example:
1 2 3 4 5 6 (4–6 digits)

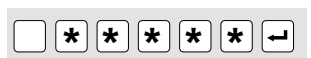

3 x Beep

**Benutzercode 2–100
Code utilisateur 2–100
Codici utente 2–100
Códigos usuarios 2–100
User codes 2–100**



Schritte A–F wiederholen
Répéter les opérations A–F
Ripetere i passi A–F
Repetir pasos A–F
Repeat steps A–F

PROGRAMMIERUNG CODE LOCK
 PROGRAMMATION CODE LOCK
 PROGRAMMAZIONE CODE LOCK
 PROGRAMACIÓN CODE LOCK
 PROGRAMMING CODE LOCK



2B

Benutzercodes entfernen
 Annuler codes utilisateurs
 Cancellare codice utente
 Anular códigos usuarios
 Delete user codes

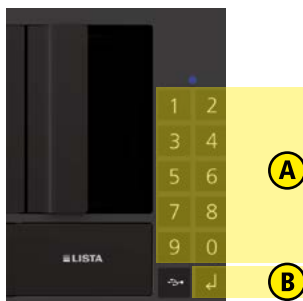

Lock-ID eingeben, (S. 7)
 Introduire le Lock-ID, (S. 7)
 Inserire il Lock-ID, (S. 7)
 Introducir Lock-ID, (S. 7)
 Enter Lock-ID, (S. 7)

Lock-ID



(8 digits)

1 x Beep

Taste 2 drücken
 Appuyer sur la touche 2
 Premere il tasto 2
 Pulse el botón 2
 Press the button 2

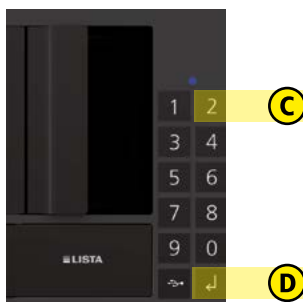

1 x Beep

Zu löschenden Benutzercode eingeben
 Introduire code utilisateur par supprimer
 Inserire codice utente per elimina
 Introducir código usuario por borrar
 Enter user code for delete

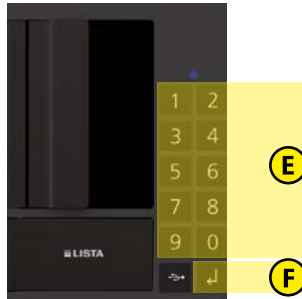

4–6 stellig
 4–6 caractères
 4–6 caratteri
 4–6 dígitos
 4–6 digits

zum Beispiel / par exemple / per esempio /
 por ejemplo / for example:
 1 2 3 4 5 6 (4–6 digits)



2 × Beep

Benutzercode 2–100
Code utilisateur 2–100
Codici utente 2–100
Códigos usuarios 2–100
User codes 2–100



Schritte A–F wiederholen
 Répéter les opérations A–F
 Ripetere i passi A–F
 Repetir pasos A–F
 Repeat steps A–F

**INITIALISIERUNG RFID LOCK
 INITIALISATION RFID LOCK
 INIZIALIZZAZIONE RFID LOCK
 INICIALIZACIÓN RFID LOCK
 INITIALIZATION RFID LOCK**



**Auslieferungszustand: LISTA Werkscode 1 2 3 4 5 ist werkseitig vorinstalliert.
 Etat de livraison, code LISTA 1 2 3 4 5 est préinstallé en usine.
 Stato alla fornitura, codice di fabbrica LISTA 1 2 3 4 5 è preinstallato.
 Código de apertura preinstalado de fábrica 1 2 3 4 5 está preinstalada de fábrica.
 LISTA factory code 1 2 3 4 5 was preset at the factory.**

Zum ersten Mal öffnen
 Premier déverrouillage
 Aperto per la prima volta
 Abrir por primera vez
 Unlocking for the first time

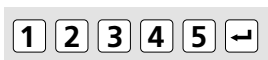

1 x Beep



Position Klappe Position volet Posizione Aletta Posición solapa Position flap	Zustand Türe État porte Stato porta Estado puerta Condition of the door	Zustand Schloss État serrure Stato serratura Estado cerradura Condition fo the lock
1	Geschlossen Fermé Chiuso Cerrado Closed	Verriegelt Verrouillage Bloccato Bloqueado Locked
2	Geschlossen Fermé Chiuso Cerrado Closed	Offen Ouvert Aperto Abierto Open
3	Offen Ouvert Aperto Abierto Open	Offen Ouvert Aperto Abierto Open

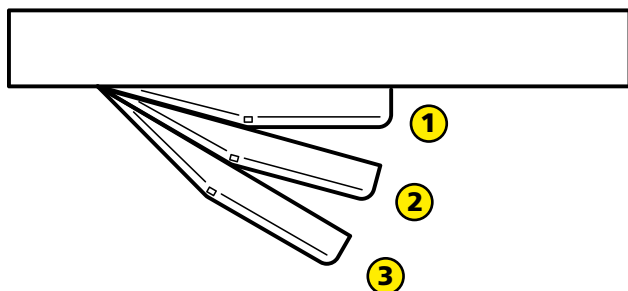

1

8-stellige Lock-ID eingeben
Introduire 8 caractères de Lock-ID
Inserire 8 cifre Lock-ID
Introducir 8 digitos Lock-ID
Enter 8 digits of Lock-ID

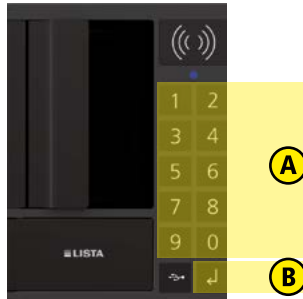

zum Beispiel / par exemple / per esempio /
 por ejemplo / for example:
 1 2 3 4 5 6 7 8 (8 digits)



(8 digits)

1 x Beep

Lock-ID wiederholen
 Répéter Lock-ID
 Ripetere Lock-ID
 Repetir Lock-ID
 Repeat Lock-ID



(8 digits)

3 x Beep

Ihre Lock-ID notieren:
 Noter votre Lock-ID:
 Nota il tuo Lock-ID:
 Tomar nota del Lock-ID:
 Note your Lock-ID:

Lock-ID



Lock-ID unbedingt in die freien Felder eintragen. Lock-ID kann nur mit LISTA Access Software geändert werden.
 Entrez Lock-ID absolument dans les champs libres. Le Lock-ID ne peut être modifiée avec le LISTA Access Software.
 Introducir Lock-ID a los campos libres. Il codice maestro può essere modificato solo con il LISTA Access Software.
 Inseririsci Lock-ID assolutamente nei campi liberi. El código maestro sólo puede cambiarse con el LISTA Access Software.
 Insert Lock-ID necessarily into the free fields. The Lock-ID can only be changed with LISTA Access Software.

Mit der Lock-ID kann der Schrank nicht geöffnet werden. Diese dient lediglich der Programmierung.
 L'armoire ne peut pas être ouverte au moyen du Lock-ID. Celui-ci sert uniquement à la programmation.
 Il Lock-ID non permette di aprire l'armadio. Serve soltanto alla programmazione.
 Con el ID de Lock no puede abrirse el armario, solo sirve para la programación.
 The cabinet cannot be opened using the Lock-ID. It is intended for programming purposes only.

**PROGRAMMIERUNG RFID LOCK
 PROGRAMMATION RFID LOCK
 PROGRAMMAZIONE RFID LOCK
 PROGRAMACIÓN RFID LOCK
 PROGRAMMING RFID LOCK**



2

**Programmier-Badge erstellen
 Réalisez badge programmable
 Realizar badge programmable
 Realizzare badge programmabile
 Create programmable badge**

8-stelligen Lock-ID erneut eingeben
 Introduire 8 caractères Lock-ID à nouveau
 Inserire 8 cifre Lock-ID nuovamente
 Introducir 8 dígitos código maestro de nuevo
 Enter 8 digits of Lock-ID again

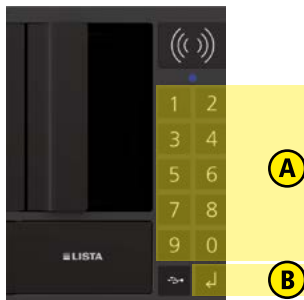

Lock-ID eingeben, (S. 13)
 Introduire le Lock-ID, (S. 13)
 Inserire il Lock-ID, (S. 13)
 Introducir Lock-ID, (S. 13)
 Enter Lock-ID, (S. 13)

Lock-ID



(8 digits)

1 x Beep

Programmier-Badge an Antenne halten
 Tenez la badge à l'antenne
 Tieni la badge l'antenna
 Colocar la badge sobre el sensor
 Hold the badge to the antenna



max. 5 Programmier-Badges möglich
 max. 5 badges programmable possible
 max. 5 badges programmabile possibile
 max. 5 badges programmabile possibile
 max. 5 programmable badges possible

3 x Beep

**Programmier-Badge 2-5
 Badge programmable 2-5
 Badge programmabile 2-5
 Badge programmabile 2-5
 Programmable badge 2-5**



Schritte A-C wiederholen
 Répéter les opérations A-C
 Ripetere i passi A-C
 Repetir pasos A-C
 Repeat steps A-C

3A

Benutzer-Badge hinzufügen
 Programmation des badge de l'utilisateur
 Programmazione del badge utente
 Programación badge usuario
 Programming user badge



Programmier-Badge an Antenne halten.
 Tenez la badge principale à l'antenne.
 Tieni la badge programmabile per l'antenna.
 Colocar la badge maestra sobre el sensor.
 Hold the master badge to the antenna.

1 x Beep



Benutzer-Badge an Antenne halten.
 Tenez la badge de l'utilisateur à l'antenne.
 Tieni la badge utente per l'antenna.
 Colocar la badge usuario sobre el sensor.
 Hold user badge to the antenna.



Badge ist angelernt
 Le badge est supprimé
 Badge é imparato
 La badge queda programada
 The badge is recognised

3 x Beep

max. Benutzer-Badge: 100
 max. Badge utilisateur: 100
 max. Badge utente: 100
 max. Badge usuarios: 100
 max. User Badge: 100



Schritte A–B wiederholen
 Répéter les opérations A–B
 Ripetere i passi A–B
 Repetir pasos A–B
 Repeat steps A–B



3B

Benutzer löschen
Supprimer l'utilisateur
Elimina utente
Borrar usuario
Delete user



Programmier-Badge an Antenne halten.
Tenez la badge principale à l'antenne.
Tieni la badge maestra per l'antenna.
Colocar la badge maestra sobre el sensor.
Hold the master badge to the antenna.

1 x Beep



Benutzer-Badge an Antenne halten.
Tenez badge de l'utilisateur à l'antenne.
Tieni badge utente per l'antenna.
Colocar badge usuario sobre el sensor.
Hold user badge to the antenna.



Badge ist gelöscht
Le badge est supprimé
Badge é cancellato
La información de la badge se borra
The badge is deleted

2 x Beep

Beim RFID Lock kann auch mit den Funktionen des CODE Locks gearbeitet werden, s. S. 8–9.
Vous pouvez utiliser le RFID Lock avec les fonctions du CODE Lock. Voir pages 8–9.
È possibile lavorare con RFID Lock anche con le funzioni di CODE Lock. Vedi pagina 8–9.
Con las funciones del CODE Lock es también posible utilizar el RFID Lock. Véanse pág. 8 y 9.
You can use the RFID Lock with the functions of the CODE Lock. See pages 8–9.

PROGRAMMIERUNG FUNKTIONEN
PROGRAMMATION FONCTIONS
PROGRAMMAZIONE FUNZIONI
PROGRAMACIÓN FUNCIONES
PROGRAMMING FUNCTIONS

Auslieferungszustand wiederherstellen
Réinitialiser l'état de Livraison
Ricreare stato di consegna
Regenerar estado en el momento de la entrega
Restore delivery status

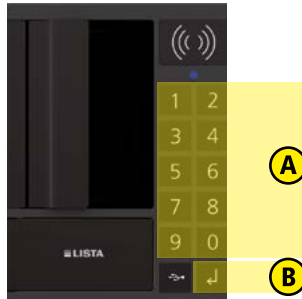

Lock-ID eingeben, (S. 7/13)
 Introduire le Lock-ID, (S. 7/13)
 Inserire il Lock-ID, (S. 7/13)
 Introducir Lock-ID, (S. 7/13)
 Enter Lock-ID, (S. 7/13)

Lock-ID



(8 digits)

1 x Beep



Achtung! Alle Einstellungen werden gelöscht!
Attention! Tous les paramètres seront effacés!
Attenzione! Tutte le impostazioni vengono cancellate!
Atención, ¡se eliminarán todos los ajustes!
Warning! All parameters will be deleted!



Zahl eingeben: 1212121212
 Introduire le nombre : 121212121212
 Inserire il numero: 121212121212
 Introducir número: 121212121212
 Enter number: 121212121212



1 x Beep

30 s warten
 Attendre 30 s
 Attendere 30 s
 Espere 30 s
 Wait 30 s



3 x Beep = gelöscht
 annulé
 cancelato
 borrado
 deleted

PROGRAMMIERUNG FUNKTIONEN
PROGRAMMATION FONCTIONS
PROGRAMMAZIONE FUNZIONI
PROGRAMACI3N FUNCIONES
PROGRAMMING FUNCTIONS

Ton ausschalten
Désactiver le son
Disattivare il suono
Desactiva el sonido
Turn off sound

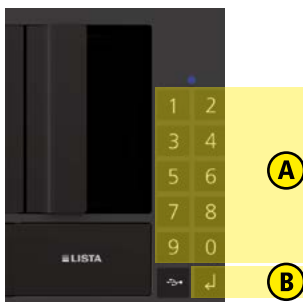

Lock-ID eingeben, (S. 7/13)
 Introduire le Lock-ID, (S. 7/13)
 Inserire il Lock-ID, (S. 7/13)
 Introducir Lock-ID, (S. 7/13)
 Enter Lock-ID, (S. 7/13)

Lock-ID



(8 digits)

Taste 8 drücken
 Appuyer sur la touche 8
 Premere il tasto 8
 Pulse el botón 8
 Press the button 8



Ton leise
Son bas
Suono basso
Sonido bajo
Sound low

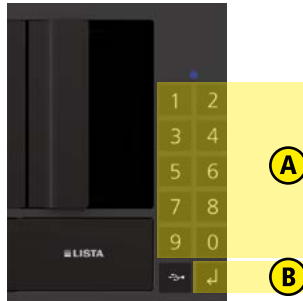

Lock-ID eingeben, (S. 7/13)
 Introduire le Lock-ID, (S. 7/13)
 Inserire il Lock-ID, (S. 7/13)
 Introducir Lock-ID, (S. 7/13)
 Enter Lock-ID, (S. 7/13)

Lock-ID



(8 digits)

Taste 9 drücken
 Appuyer sur la touche 9
 Premere il tasto 9
 Pulse el botón 9
 Press the button 9



PROGRAMMIERUNG FUNKTIONEN
PROGRAMMATION FONCTIONS
PROGRAMMAZIONE FUNZIONI
PROGRAMACI3N FUNCIONES
PROGRAMMING FUNCTIONS

Ton laut
Son fort
Suono forte
Sonido fuerte
Sound loud

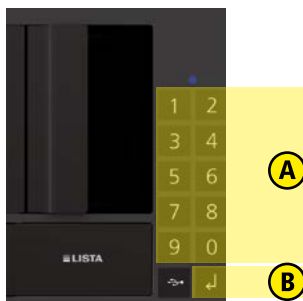

Lock-ID eingeben, (S. 7/13)
Introduire le Lock-ID, (S. 7/13)
Inserire il Lock-ID, (S. 7/13)
Introducir Lock-ID, (S. 7/13)
Enter Lock-ID, (S. 7/13)

Lock-ID



(8 digits)

Taste 0 drücken
Appuyer sur la touche 0
Premere il tasto 0
Pulse el botón 0
Press the button 0



STANDARD ESD SCHUTZ
PROTECTION ESD STANDARD
PROTEZIONE STANDARD ESD
PROTECCIÓN ESD ESTÁNDAR
STANDARD ESD PROTECTION

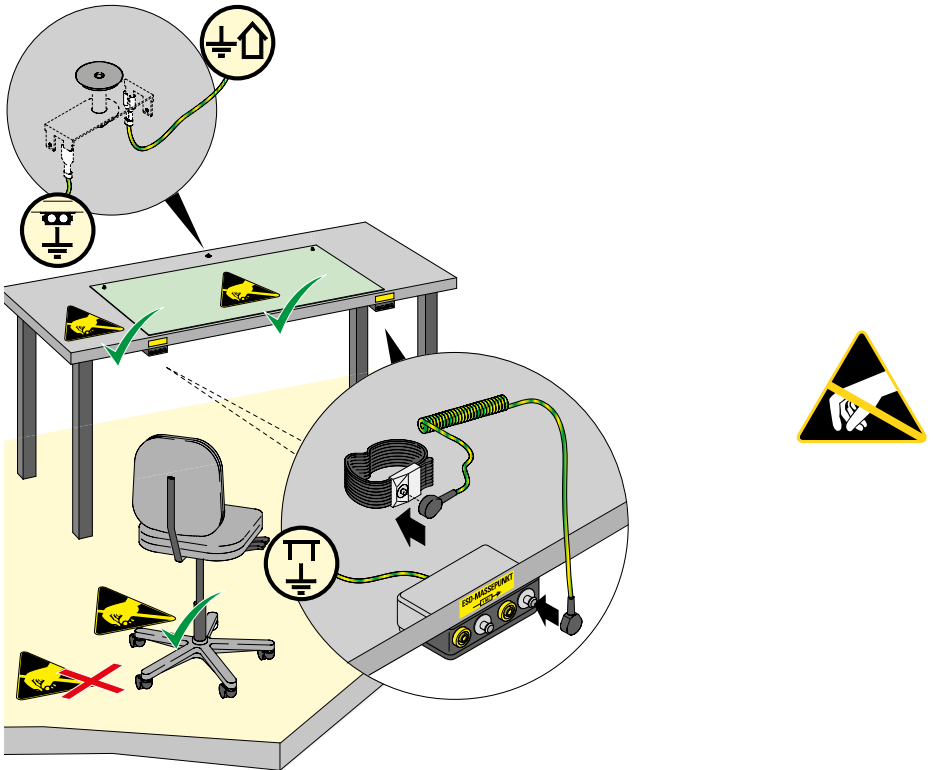

**MODULAUSTAUSCH
REPLACEMENT DES MODULES
SOSTITUZIONE MODULI
SUSTITUCIÓN MÓDULO
MODULE REPLACEMENT**

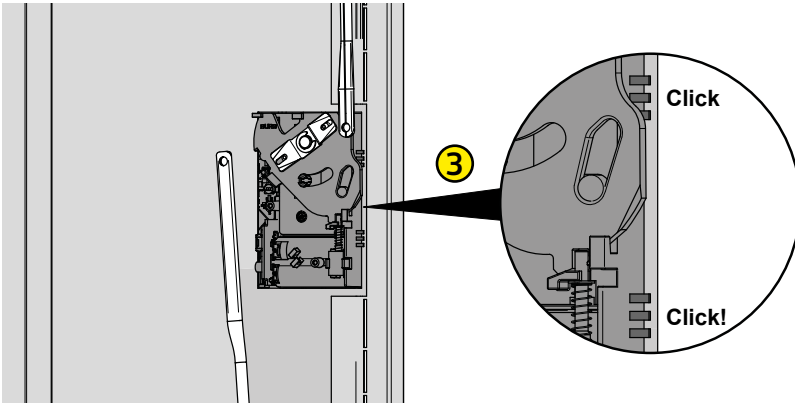
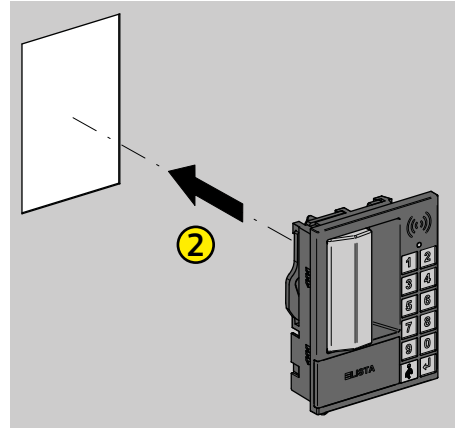
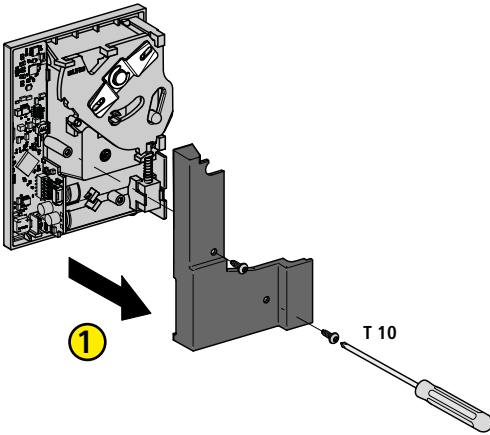

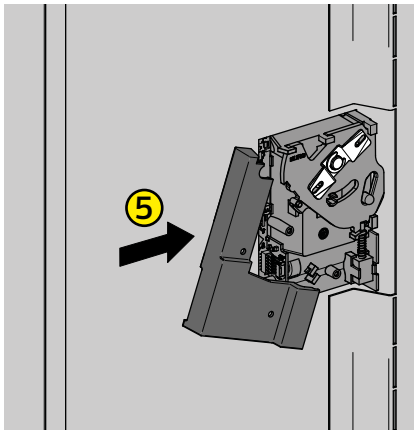
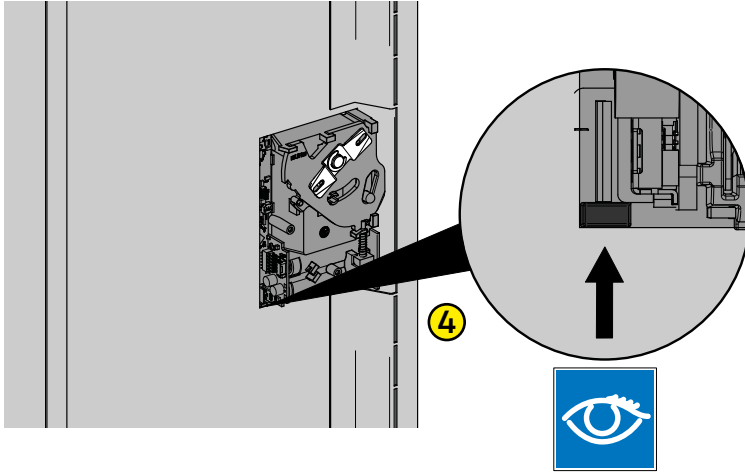

MODULAUSTAUSCH
REPLACEMENT DES MODULES
SOSTITUZIONE MODULI
SUSTITUCIÓN MÓDULO
MODULE REPLACEMENT

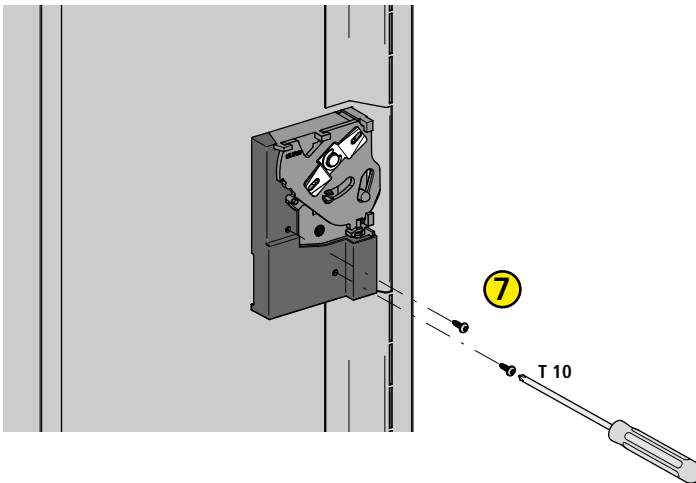
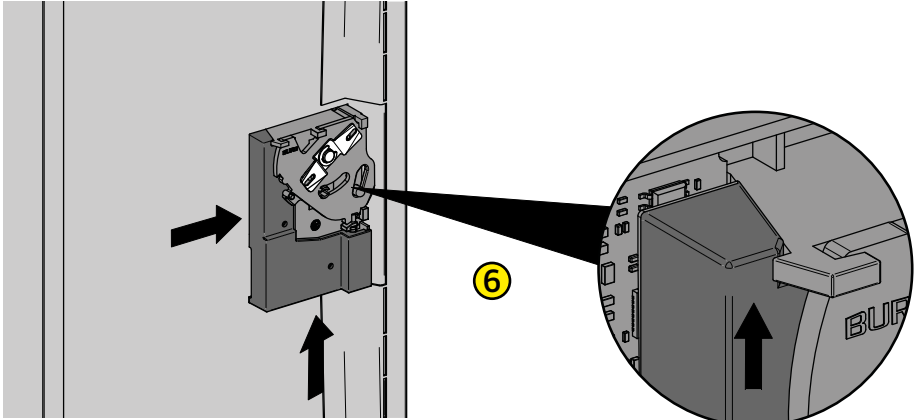

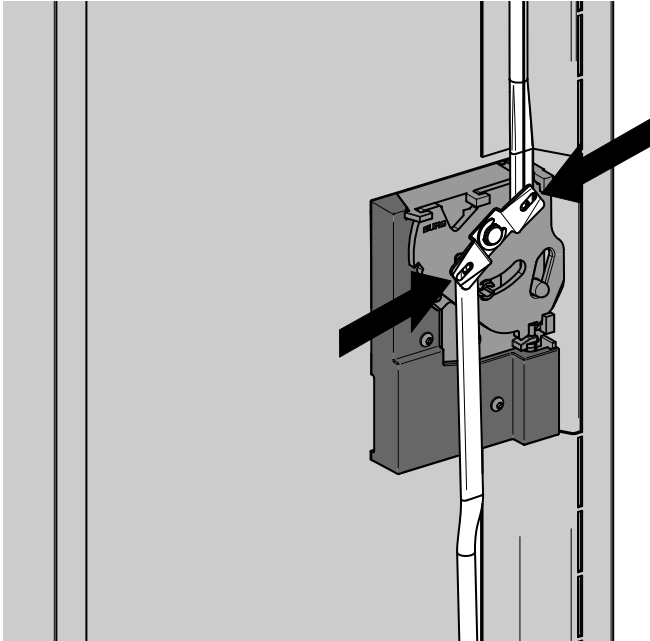

**BATTERIEWECHSEL
 REMPLACEMENT DE BATTERIE
 SOSTITUZIONE DELLA BATTERIA
 CAMBIO DE BATERÍA
 CHANGING BATTERY**



Batterielebensdauer: bis zu 1 Jahr je nach Nutzungs-
 frequenz.

Durée de vie des piles : jusqu'à 1 an en fonction de
 la fréquence d'utilisation.

Durata della batteria: fino a 1 anno a seconda della
 frequenza di utilizzo.

Vida útil de la pila: hasta 1 año en función de la fre-
 cuencia de uso.

Battery life: up to 1 year depending on frequency of
 use.



Auf Polarität achten
 Prendre garde à la polarité
 Tenere conto della polarità
 Respetar las polaridades
 Observe polarity

Codes bleiben gespeichert
 Les codes restent mémorisés
 I codici rimangono memorizzati
 Los códigos permanecen memorizados
 Codes remain saved

**FEHLERSUCHE
DÉTECTION D'ERREURS
RICERCA GUASTI
BÚSQUEDA DE ERRORES
TROUBLESHOOTING**

Fehler	mögliche Ursache	Behebung
Schloss reagiert nicht	Keine Batterien vorhanden	Batterien einsetzen
	Batterien falsch eingesetzt	Batterien korrekt einsetzen
	Batterien leer	Neue Batterien einsetzen
	Systemfehler	Batterien ausbauen und wieder einbauen
	Schloss defekt	Schloss austauschen
Lock-ID kann nicht eingegeben werden	Die zwei Codes sind nicht identisch	Siehe Lock-ID hinzufügen
	Code hat nicht 8 Ziffern	Code mit 8 Ziffern eingeben
Benutzercode kann nicht eingegeben werden	Code hat nicht 4–6 Ziffern	Code mit 4–6 Ziffern eingeben
	Die Taste 1 für Benutzer hinzufügen wurde nicht gedrückt	Siehe Benutzer hinzufügen
Drehknopf kann nicht gedreht werden	Drehknopf wurde zu früh gedreht und blockiert den Magnetanker	Drehknopf erst drehen, wenn die grüne LED leuchtet
	Batterie leer und Magnet zieht nicht mehr an	Neue Batterien einsetzen
Beeper arbeitet nicht	Funktion Beeper ist ausgeschaltet	Siehe Lautstärke des Beepers einstellen
LED arbeitet nicht	LED defekt	Schloss austauschen
LED blitzt rot auf und kurzes akustisches Signal	Batterien leer	Neue Batterien einsetzen
User Badge öffnet das Schloss nicht	Badge ist noch nicht gespeichert	Siehe Benutzer hinzufügen, mit Master Badge
	Badge ist schon als Master Badge angelernt	User Badge verwenden
User Badge kann nicht angelernt werden	User Badge ist nicht kompatibel	RPID Standard vom User Badge prüfen

FEHLERSUCHE DÉTECTION D'ERREURS RICERCA GUASTI BÚSQUEDA DE ERRORES TROUBLESHOOTING

Erreurs	Causes possibles	Remèdes
La serrure ne réagit pas	Aucune pile n'a été insérée	Insérer les piles
	Insertion incorrecte des piles	Insérer correctement les piles
	Piles épuisées	Insérer de nouvelles piles
	Erreur système	Retirer et remettre en place les piles
	Serrure défectueuse	Remplacer la serrure
Lock-ID ne peut pas être saisi	Les deux codes ne sont pas identiques	Voir ajouter Lock-ID
	Code n'a pas 8 chiffres	Saisir le code à 8 chiffres
Le code d'utilisateur ne peut pas être saisi	Code n'a pas 4–6 chiffres	Saisir le code à 4–6 chiffres
	La touche 1 pour Ajouter utilisateur n'a pas été enfoncée	Voir ajouter utilisateur
Le bouton rotatif ne peut pas être tourné	Le bouton rotatif a été tourné trop tôt et bloque l'induit magnétique	Tourner le bouton rotatif seulement une fois que la LED verte s'est allumée
	Pile épuisée et l'aimant ne réagit plus	Insérer de nouvelles piles
Le beeper ne fonctionne pas	La fonction beeper est désactivée	Voir régler le volume sonore du beeper
LED ne fonctionne pas	LED défectueuse	Remplacer la serrure
Voyant LED clignote en rouge et bref signal sonore	Piles épuisées	Insérer de nouvelles piles
User badge ne peut pas ouvrir la serrure	Le badge n'a pas encore été enregistré	Voir ajouter utilisateur avec master badge
	Le badge a déjà été initié comme master badge	Utiliser user badge
User badge ne peut pas être initié	User badge n'est pas compatible	Vérifier RFID Standard du user badge

Guasto	Possibile causa	Rimedio
La serratura non risponde	Nessuna batteria presente	Inserire le batterie
	Batterie inserite in modo errato	Inserire correttamente le batterie
	Batterie scariche	Inserire le batterie nuove
	Errore di sistema	Rimuovere e rimontare le batterie
	Serratura difettosa	Sostituire la serratura
Il Lock-ID non può essere inserito	I due codici non sono identici	Vedi aggiungere il Lock-ID
	Il codice ha non 8 cifre	Inserire il codice di 8 cifre
Il codice utente può essere inserito	Il codice ha non 4–6 cifre	Inserire il codice di 4–6 cifre
	Il tasto 1 per Aggiungi utente non è stato premuto	Vedi aggiungere utente
La manopola non può essere girata	La manopola è stata girata troppo presto e blocca l'ancoraggio magnetico	Girare la manopola quando il LED si accende in verde
	La batteria è vuota e il magnete non attira più	Inserire le batterie nuove
Il segnalatore acustico non funziona	La funzione del segnalatore acustico è spento	Vedi impostare il volume del segnalatore acustico
Il LED non funziona	LED difettoso	Sostituire la serratura
Il LED lampeggia in rosso ed emette un breve segnale acustico	Batterie scariche	Inserire le batterie nuove
Lo user badge non apre la serratura	Badge non è ancora memorizzato	Vedi aggiungere utente con master badge
	Il badge è imparato come master badge	Utilizzare lo user badge
Lo user badge non può essere programmato	Lo user badge non è compatibile	Controllare RPID Standard dallo user badge

FEHLERSUCHE

DÉTECTION D'ERREURS

RICERCA GUASTI

BÚSQUEDA DE ERRORES

TROUBLESHOOTING

Error	Causa posible	Eliminación
La cerradura no reacciona	No existe ninguna pila	Insertar pilas
	No existe ninguna pila	Insertar las pilas correctamente
	Pilas descargadas	Insertar pilas nuevas
	Error de sistema	Sacar y volver a instalar las pilas
	Cerradura defectuosa	Sustituir la cerradura
No se puede entrar el código maestro	Los dos códigos no son idénticos	Véase agregar código maestro
	El código no tiene 8 cifras	Entrar código de 8 cifras
No se puede entrar el código de usuario	El código no tiene 4 a 6 cifras	Entrar código de 4 a 6 cifras
	No se ha pulsado la tecla 1 para usuario	Véase agregar usuario
El botón giratorio no se puede girar	El botón giratorio se ha girado demasiado temprano y está bloqueando el inductor magnético	Apenas girar el botón giratorio cuando el LED verde esté iluminado
	Pila descargada e imán ya no atrae	Insertar pilas nuevas
El biper no funciona	Funcionamiento de biper está apagado	Véase ajustar el volumen del biper
El LED no funciona	LED defectuoso	Sustituir la cerradura
El LED parpadea en rojo y se emite una breve señal acústica	Pilas descargadas	Insertar pilas nuevas
User badge no abre la cerradura	Badge todavía no está almacenado	Véase agregar usuario con master badge
	Badge ya está entrenado como master badge	Usar user badge
User badge no se puede entrenar	User badge no es compatible	Controlar RPID Standard del user badge

Error	Possible cause	Rectification
Lock does not react	No batteries installed	Install batteries
	Batteries installed incorrectly	Install batteries correctly
	Batteries discharged	Install new batteries
	System error	Remove batteries and re-fit
	Lock faulty	Replace lock
It is not possible to enter Lock-ID	The two codes are not identical	See adding Lock-ID
	Code does not have 8 digits	Enter code with 8 digits
It is not possible to enter user code	Code does not have 4–6 digits	Enter code with 4–6 digits
	Button 1 for adding user has not been pressed	See adding user
Rotary knob cannot be rotated	Rotary knob was rotated too early and is blocking the solenoid armature	Only rotate rotary knob once the green LED is illuminated
	Battery discharged and solenoid no longer energises	Install new batteries
Beeper does not work	Beeper function is switched off	See adjusting volume of the beeper
LED does not work	LED faulty	Replace lock
The LED will blink red and a short acoustic signal will sound	Batteries discharged	Install new batteries
User badge does not open the lock	Badge has not yet been saved	See adding user with master badge
	Badge has already been taught-in as master badge	Use user badge
User badge cannot be taught-in	User badge is not compatible	Check RPID standard of the user badge

Lista AG
Fabrikstrasse 1
CH-8586 Erlen
Telefon +41 71 649 21 11
Telefax +41 71 649 22 03
info@lista.com
www.lista.com



www.lista.com